

## 6 CHARGING YOUR ZAP CANE



### IMPORTANT: Make sure the unit is in POWER OFF position for charging.

- Connect the wall charger to the charging socket of the unit, then to wall outlet
- The charging indicator light (red LED) on wall charger will come on, showing that the battery is charging
- The red charging indicator will go off when the wall charger has been removed from the unit or from wall unit.
- The ZAP Cane should be always be charged for 4 hours.
- Battery life is best if recharged only when batteries are completely low.
- Body of device may become warm while charging
- Charging at temperatures below 40°F and higher than 95°F adversely affects lifetime of batteries.
- If the unit has not been used for at least 2 months, it must be recharged.

**NOTE: if flashlight feature is working, but the stun gun is not working, the unit is not defective, please recharge immediately.**

## LIMITED TWO-YEAR WARRANTY

All CANARMOR™ products are guaranteed for 2 years from purchase date to be free from defective materials and workmanship.

1. The warranty does not cover damage resulting from accident, misuse or abuse, lack of reasonable care, moisture, the affixing of any attachment not provided with the product, loss of parts or recharging the unit in any manner not in accordance with the included instructions.
2. The warranty will be voided if the unit has been opened or tampered with in any way (unless by an authorized dealer) or if any unauthorized replacement parts have been used.

### TO OBTAIN SERVICE:

For technical support or assistance with your CANARMOR™ product, please call 1-905-884-8338. Damage or loss occurring during shipment is not covered by this warranty.

CONDITIONS OF SALE: Purchase of this product is an agreement by the purchaser/user to hold all sellers and manufacturers harmless of all liabilities and damages. The purchaser/user assumes all responsibility for the use and misuse of this product. Check your state and local laws in regard to possession and/or use of stun guns.



**CANADIAN ARMOUR, LTD.**

Tel. 1-905-884-8338

WWW.canarmor.ca • sales@canarmor.ca

**READ and SAVE these instructions before charging and before use.**

# ZAP CANE™ STUN CANE with FLASHLIGHT

MODEL ZAPCANE - ONE MILLION VOLTS

- With ultra-bright LED flashlight



- Built-in rechargeable Ni-MH battery

- Adjustable length 32-36"

- Weight capacity 250 lbs.

- With removable reflective safety band

- Includes wall charger, carrying case and extra rubber tip



PS PRODUCTS  
PATENT #  
US D611,114S

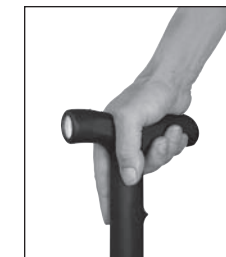

## 1 WARNING

- This device is not water-resistant. Keep away from water, rain, etc. If any liquid or foreign object has entered the unit, do not use, consult your authorized dealer.
- Do not touch the internal parts. These are high tension circuits that may cause severe electric shock.
- Do not open, disassemble or modify this device, as it may cause damage to the unit. For internal repairs, consult your authorized dealer.

- Keep away from flammable materials.
- Never store near hot objects, in direct sunlight or at a temperature above 140°F.
- Keep out of reach of children.
- Use only in a lawful manner. Check state and local laws for stun gun restriction
- Do not discharge the unit into the air for more than 1 second at a time. Continuous firing for a longer duration can damage unit and will void the warranty.
- This device may only be sold to a person 18 years or older.

## 2 YOUR ZAP CANE

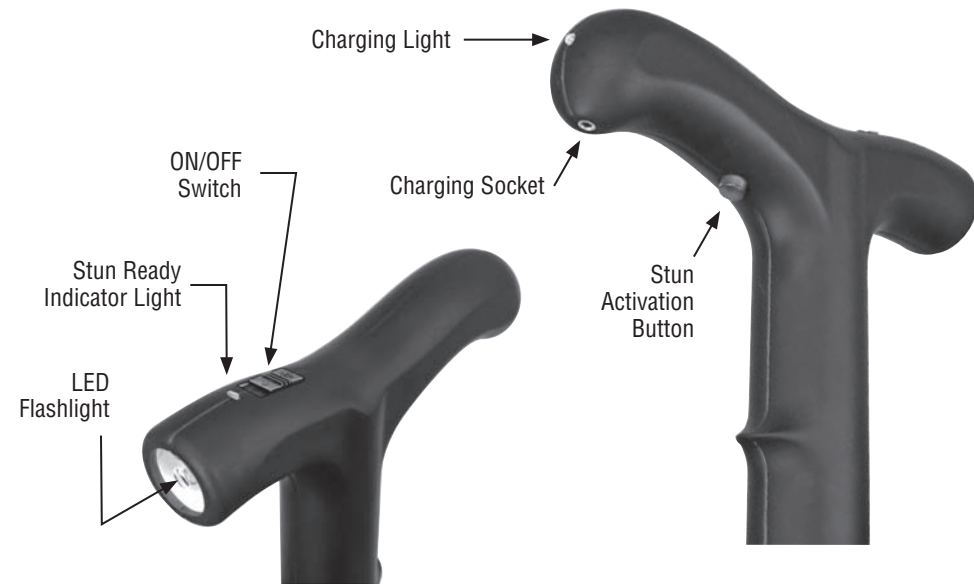

### STUN-READY INDICATOR LIGHT

When ON/OFF Switch is in Stun-Ready (UP) position, the red Stun-Ready light comes on to indicate the unit is ready for use.

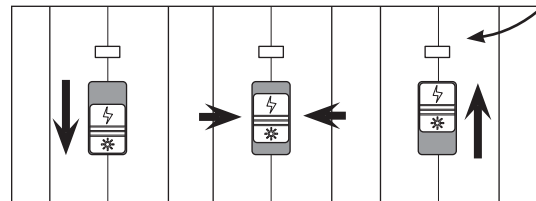

**DOWN** position: Power off  
**MIDDLE** position: Flashlight only  
**UP** position: Stun ready

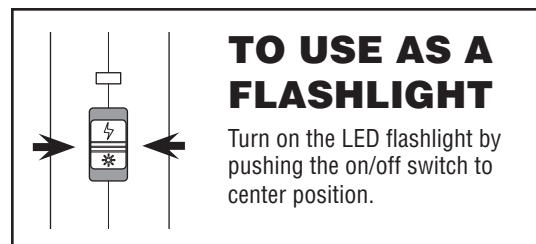

### TO USE AS A FLASHLIGHT

Turn on the LED flashlight by pushing the on/off switch to center position.

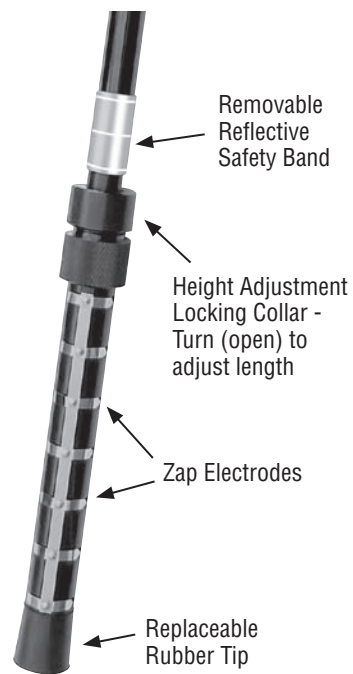

## 3 ADJUSTING HEIGHT OF YOUR ZAP CANE™

**WARNING:** Before adjusting, make sure the ON/OFF switch is in OFF position.

1. Loosen the top locking collar, approx. 3 full turns, and lift up.



Do not pull the lower section past the "STOP HERE" warning on the handle shaft. If this does happen, re-align according to the diagrams at the right.



3. Move height adjustment stop ring to desired position, keeping in mind each segment on shaft is 1". You will hear a loud click as the stop ring slides over each segment. Make sure the stop ring is snapped securely into position. Your ZAP CANE may be lengthened by up to 6".

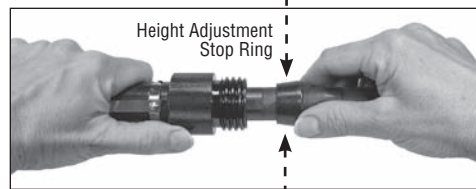

2. Pull lower section of ZAP CANE out from upper section. Avoid pulling the electrode section all the way off, as it may be difficult to re-align\*.

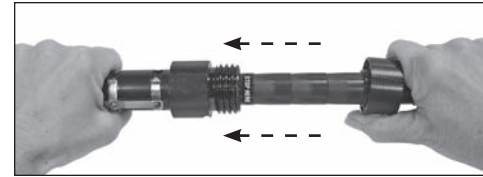

**\*IMPORTANT:** If lower electrode section of ZAP CANE is pulled away from the handle shaft, you must align the copper strips on handle shaft directly with the electrode strips on the lower section, as shown below.

Incorrect alignment may result in malfunction or damage to your ZAP CANE. Always test fire after assembly or adjustments.

### CORRECT alignment

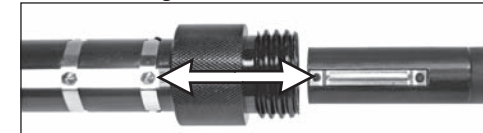

### INCORRECT alignment

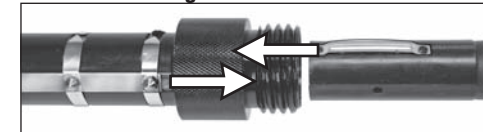

4. Push the top locking collar down over the height adjustment stop ring, and firmly push the electrode section up over the height adjustment ring. Tighten the top locking collar.



## 4 ADJUSTING HEIGHT OF YOUR ZAP CANE™

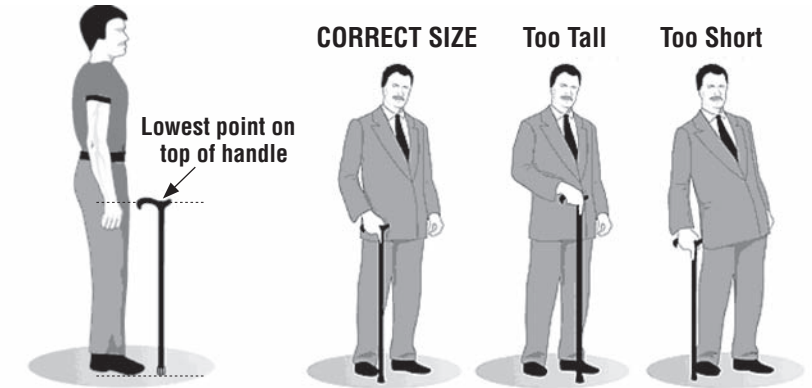

Note: this information in no way replaces a medical professional's recommendation. Canes are not intended to be used like a crutch for full weight support, canes are intended only for balance.

## 5 USE AS A STUN GUN

**USE A ZAP™ STUN GUN ONLY AS A DEFENSIVE WEAPON.** This product is suitable to be carried at all times, including walking, jogging, hiking, bicycling, entering or leaving buildings, etc. The ZAP™ should only be used when you would be justified to prevent an unwanted encounter.

**PUSH THE STUN ACTIVATION BUTTON** to discharge the unit.

**A SHORT BLAST** (1/4 second) will startle an attacker, cause minor muscle contractions and can have a repelling effect.

**A MODERATE BLAST** (1 - 4 seconds) can cause attacker to fall and can cause mental confusion. It may make the assailant unwilling to continue attack, but they will be able to get up almost immediately.

**A FULL BLAST** of 5 seconds or more can immobilize an attacker, causing disorientation, loss of balance, falling to the ground, weakness and leaving them dazed for several minutes afterwards.

**THE ZAP™ CHARGE** will have an effect anywhere on the body, but the maximum effect is in areas marked with an "X" in the drawing.

While using a ZAP™ Stun Gun, you cannot suffer a charge-back to your own body, even if the attacker is holding you.

**BATTERIES:** Test fire your ZAP™ Stun Gun periodically for familiarity, performance and reliability. You should replace batteries or recharge when electrical arc gets weak.

**Always keep stun guns out of the reach of children. Keep away from flammable gasses, as an explosion may occur. Must be 18 to purchase. ID check required. Check state and local laws regarding product usage.**

